

eMMC FLASH Programming User's Guide



Release 09.2025

eMMC FLASH Programming User's Guide

TRACE32 Online Help

TRACE32 Directory

TRACE32 Index

TRACE32 Documents	
FLASH Programming	
eMMC FLASH Programming User's Guide	1
Introduction	4
How This Manual is Organized	4
Related Documents	4
Contacting Support	5
List of Abbreviations	7
Background Knowledge	8
What is an eMMC Flash Device?	8
About Blocks and Pages	8
About eMMC Interface Controllers in eMMC Flash Memories	9
Standard Approach	10
Identifying and Running Scripts for eMMC Flash Programming	10
If There Is No Script	12
Scripts for eMMC Controllers	13
Establishing Communication between Debugger and Target CPU	14
Configuring the eMMC Controller	15
Resetting Default Values	16
Informing TRACE32 about the eMMC Controller Address	16
Informing TRACE32 about the eMMC Flash Programming Algorithm	16
Identifying the Correct Driver Binary File for an eMMC Flash Device	18
File Name Convention for eMMC Flash Drivers	18
Example for eMMC Controllers	19
FLASHFILE Declaration Examples	20
Declaration Example 1	20
Declaration Example 2	21
Checking the Identification from the eMMC Flash Device	22
Erasing the eMMC Flash Device	23
Programming the eMMC Flash Device	23
Copying the eMMC Flash Memory	24
Modifying the eMMC Flash Memory	26
Other Useful Commands	27

Reading the eMMC Flash	27
Saving the eMMC Flash Device	28
Full Examples	29
Example 1	29
Example 2	31
FLASH Programming via Boundary Scan	32

Introduction

This manual describes the basic concept of eMMC Flash programming.

How This Manual is Organized

- **About eMMC Interface Controllers in eMMC Flash Memories:** Provides background information about the topic.
- **Standard Approach:** Describes the fastest way to get started with eMMC Flash programming. All you need to do is to identify and run the correct script.
Demo scripts for eMMC Flash programming are available in the folder:
`~/demo/<architecture>/flash/*.cmm`
e.g. `at91sam3u-emmc.cmm`, `omap3530-emmc.cmm`, ...
- **New Scripts for eMMC Controllers:** Describes how you can create a script if there is no demo script for the eMMC controller you are using.

Related Documents

A complete description of all eMMC Flash programming commands can be found in chapter **“FLASHFILE”** in **“General Commands Reference Guide F”** (`general_ref_f.pdf`).

The Lauterbach home page provides an up-to-date list of

- Supported Flash devices under:
www.lauterbach.com/supported-platforms/toolchain/flash-devices
- Supported eMMC Flash controllers under:
www.lauterbach.com/supported-platforms/toolchain/flash-controllers

Contacting Support

Use the Lauterbach Support Center: <https://support.lauterbach.com>

- To contact your local TRACE32 support team directly.
- To register and submit a support ticket to the TRACE32 global center.
- To log in and manage your support tickets.
- To benefit from the TRACE32 knowledgebase (FAQs, technical articles, tutorial videos) and our tips & tricks around debugging.

Be sure to include detailed system information about your TRACE32 configuration.

1. To generate a system information report, choose **TRACE32 > Help > Support > Systeminfo**.

The screenshot shows the 'Generate TRACE32 Support Information' dialog box. The form is filled with the following data:

Company:	Lauterbach	Department:	
Prefix:			
Firstname:	Andrea		
Surname:	Martin		
Street:	Altlaufstr. 40	P.O. Box:	
City:	Hoehenkirchen-Siegertsbr.	ZIP Code:	85635
Country:	Germany		
Telephone:	(+49) 8102-9876-555		
eMail:	andrea.martin@lauterbach.com		
Product:	PowerTrace PX		
Target CPU:	ARM940T		
Hostsystem:	Windows 10		
Compiler:	Arm		
RealtimeOS:	Nono		

At the bottom of the dialog box, there are three buttons: 'Generate Support Information:', 'Save to Clipboard', and 'Save to File'. The 'Generate Support Information:' button is highlighted.

NOTE:

Please help to speed up processing of your support request. By filling out the system information form completely and with correct data, you minimize the number of additional questions and clarification request e-mails we need to resolve your problem.

2. Preferred: click **Save to File**, and send the system information as an attachment to your e-mail.
3. Click **Save to Clipboard**, and then paste the system information into your e-mail.

NOTE:

In case of missing script files (* .cmm), please proceed as requested in **“If There is No Script”**.

List of Abbreviations

CS	Chip selection
eMMC	Embedded multimedia card
GPIO	General purpose input/output
JEDEC	Joint Electron Device Engineering Council
MISO	Master input, slave output
MMC	Multimedia card
MMCA	MultiMediaCard Association
MOSI	Master output, slave input
SCLK	Serial clock
SDI	Serial data input
SDO	Serial data output
SPI	Serial peripheral interface
SS	Slave select
SSI	Synchronous serial interface

Background Knowledge

This chapter of the manual is aimed at users who are new to eMMC Flash programming; it does not address experts with many years of expertise in this area. This chapter gives you a brief overview of important terms in eMMC Flash programming, such as eMMC interface controller, sector, and block.

What is an eMMC Flash Device?

An eMMC Flash device is a non-volatile, rewritable mass storage device. It is used in consumer products such as mobile phones, PDAs, and digital cameras. Reasons why eMMC Flash devices have become widespread include:

- High data storage capacity
- Easy to integrate into the host system
- The eMMC standard developed by the MMCA and the JEDEC is an open, royalty-free standard.

About Blocks and Pages

Sector	A sector has a size of 512 bytes, the same size as a sector in the FAT file system under DOS.
Block	A page is the minimum size unit for writing and reading. The size is configurable (512, 1024, 2048 bytes), but normally the size is 512 bytes.

About eMMC Interface Controllers in eMMC Flash Memories

eMMC Flash memories include an interface controller and a Flash memory. Access to the Flash memory is performed by the interface controller on the slave side.

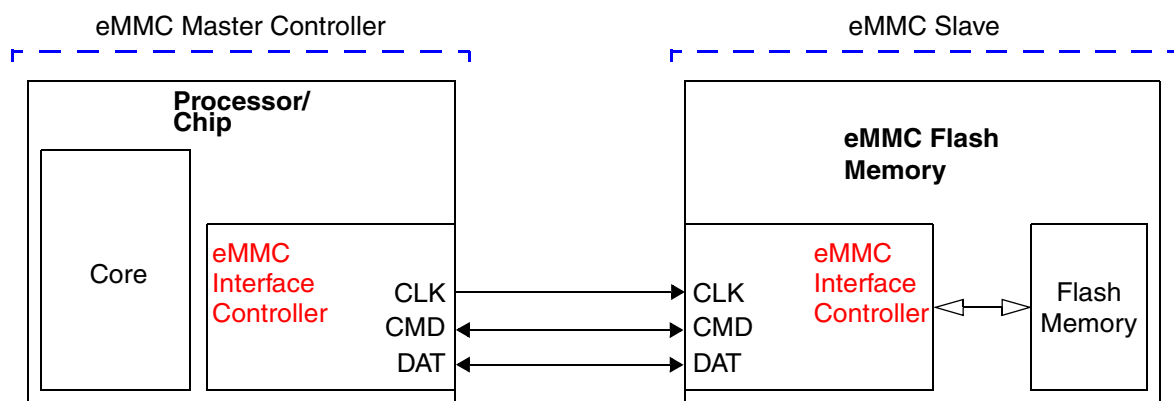

Figure: Processor/Chip and eMMC Flash Memory with an eMMC Interface

The protocol of the eMMC interface has three communication signals:

- MCC clock (CLK)
- Command in / response out (CMD)
- Data input / output (DAT)

Most chip manufacturers have their own MMC interface controllers (short: MMC controllers). As a result, MMC controllers require special driver binary files for programming eMMC Flash memories. These driver binary files are provided by Lauterbach.

Once the required driver binary file has been loaded to the target board, the eMMC Flash memory can be programmed and erased using the **FLASHFILE** command group in TRACE32.

Standard Approach

Standard Approach provides a compact description of the steps required to program eMMC Flash memories. This description is intentionally restricted to the standard use case.

For a detailed description of the eMMC Flash programming concepts, see “[Scripts for eMMC Controllers](#)”, page 13.

Identifying and Running Scripts for eMMC Flash Programming

Demo scripts (*.cmm) for eMMC Flash programming are provided by Lauterbach. They can be found in the TRACE32 installation directory. It contains scripts for programming eMMC Flash memories.

Path and file name convention of scripts to be used with eMMC controllers:

```
~/demo/<architecture>/flash/<cpu_name>-<emmc_flash_code>.cmm
```

Where ~ is expanded to the *<trace32_installation_directory>*, which is c:/t32 by default.

To identify and run the required script:

1. Make a note of the *<cpu_name>* printed on the CPU; for example, **dm365**.
2. For information about supported Flash devices, access the [Lauterbach](#) website.
3. Click the + tree button next to **Tool Chain**, and then click **Supported Flash Devices** (www.lauterbach.com/supported-platforms/toolchain/flash-devices).
4. On the **Supported Flash Devices** page, select the required company from the drop-down list.

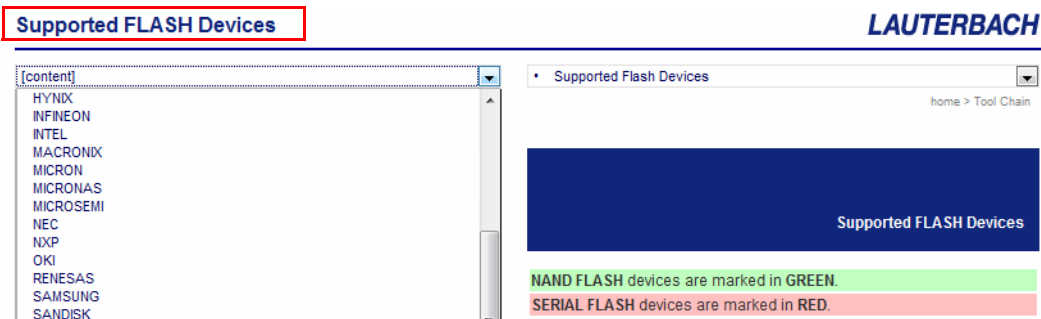

- Use the type printed on the Flash device to retrieve the `<emmc_flash_code>` from the web page.

For example, eMMC Flash type = NAND16GXH

TYPE	COMPANY	CODE	COMMENT
28F00AM29EW	MICRON	M29EW M29EWB	16-bit mode 8-bit mode
⋮	⋮	⋮	⋮
NAND08GW3B	MICRON	NAND2G08L	NAND-Flash
NAND16GXH	MICRON	eMMC	eMMC
NAND32GXH	MICRON	eMMC	eMMC

Result: `<emmc_flash_code>` = emmc

- Put the `<cpu_name>` and the `<emmc_flash_code>` together to form the script name:

dm365-emmc.cmm

The script resides in this folder: `~/~/demo/arm/flash/dm365-emmc.cmm`

Where `~/~/` is expanded to the `<trace32_installation_directory>`, which is `c:/t32` by default.

If the folder does not contain the script you are looking for, see [“Scripts for eMMC Controllers”](#), page 13.

- Run the script in TRACE32 by doing one of the following:

- Choose **File > Run Script** `<cmm_script_name>`
- In the command line, type **DO** `<cmm_script_name>`

NOTE: Each script (*.cmm) includes a reference to the required eMMC Flash programming algorithm (*.bin).
You do not need to program or select the algorithm.

Example

```

;                                <code_range>          <data_range>          <file>
FLASHFILE.TARGET 0x20000000++0x1FFF 0x20002000++0x1FFF
                                ~/~/demo/arm/flash/byte/emmc_at91sam.bin

```

If There Is No Script

If there is no script for your device in this directory (`~/~/demo/<architecture>/flash/`), please submit a request at support.lauterbach.com/new-ticket using the e-mail template below.

E-Mail Template:

Chip name: _____

Name of serial Flash device: _____

Provide the CPU datasheet for us: _____

Lend the target board to us by sending it to the address given in “[Contacting Support](#)”: _____

<system_information>

Be sure to include detailed system information about your TRACE32 configuration. For information about how to create a system information report, see “[Contacting Support](#)”.

Normally we can provide support for a new device in two weeks.

If our support cannot provide you with a PRACTICE script, you will have to create your own PRACTICE script (*.cmm).

For more information, see “[Scripts for eMMC Controllers](#)”, page 13.

Scripts for eMMC Controllers

This chapter describes how to create new scripts for eMMC Flash memories that are equipped with eMMC controllers.

The steps and the framework (see below) provide an overview of the process. They are described in detail in the following sections.

The following steps are necessary to create a new script:

1. Establish communication between debugger and target CPU.
2. Configure the eMMC controller.
3. Reset the eMMC Flash environment in TRACE32 to its default values.
4. Inform TRACE32 about the eMMC Flash register addresses (Flash declaration).
5. Inform TRACE32 about the eMMC Flash programming algorithm.
6. Check the identification from the eMMC Flash device.
7. Erase the eMMC Flash device.
8. Program the eMMC Flash device.

The following framework can be used as base for eMMC Flash programming:

```
                                ; Establish the communication
                                ; between the target CPU and the
                                ; TRACE32 debugger.

                                ; Configure the eMMC controller.

FLASHFILE.RESet                ; Reset the eMMC Flash environment
                                ; in TRACE32 to its default values.

FLASHFILE.CONFIG ...          ; Specify the base address of the
                                ; control register of the eMMC
                                ; controller.

FLASHFILE.TARGET ...          ; Inform Trace 32 about:
                                ; - the FLASH programming algorithm
                                ; - the <code_address> and
                                ;   the <data_address> for the
                                ;   FLASH programming algorithm

FLASHFILE.Erase ...           ; Erase the eMMC Flash.

FLASHFILE.LOAD <main_file> ... ; Program the file to eMMC Flash.
```

An ellipsis (...) in the framework indicates that command parameters have been omitted here for space economy.

NOTE:	The parametrization of FLASHFILE.CONFIG and FLASHFILE.TARGET requires expert knowledge.
--------------	---

Establishing Communication between Debugger and Target CPU

eMMC Flash programming with TRACE32 requires that the communication between the debugger and the target CPU is established. The following commands are available to set up this communication:

SYStem.CPU <cpu>

Specify your target CPU.

SYStem.Up

Establish the communication between the debugger and the target CPU.

```
SYStem.CPU AT91SAM3U4          ; Select AT91SAM3U4 as the target CPU.
```

```
SYStem.Up                      ; Establish the communication between the
                                ; debugger and the target CPU.
```

Configuring the eMMC Controller

Programming a eMMC Flash device requires an appropriate initialization of the eMMC Flash interface. The following settings might be necessary:

- Enable the clock (CLK).
- Configure the registers of the eMMC Flash interface, such as clock, master/slave, data width, etc.
- Configure the eMMC Flash pins if they are muxed with other functions of the CPU.

Example

```
Data.Set 0x400E1254 %LE %Long 0x3FFFFFFF ; Disable watchdog.  
; LE = little endian  
  
Data.Set 0x400E0C04 %LE %Long 0x1F8 ; Switch from the GPIO.A  
; pins to the eMMC pins.  
  
Data.Set 0x400E0430 %LE %Long 0x11 ; Enable the eMMC clock.  
Data.Set 0x400E0410 %LE %Long 0x20000  
  
Data.Set 0x40000008 %LE %Long 0x7F ; Configure the eMMC  
Data.Set 0x4000000C %LE %Long 0x00 ; controller (for example,  
Data.Set 0x40000054 %LE %Long 0x1 ; bus width, clock speed and  
Data.Set 0x40000004 %LE %Long 0x73B ; time-out).  
  
Data.Set 0x40000000 %LE %Long 0x1 ; Enable the eMMC  
; controller.
```

Resetting Default Values

The following command is used to reset the eMMC Flash environment in TRACE32 to its default values.

FLASHFILE.RESet

Reset the eMMC Flash environment in TRACE32 to its default values.

Informing TRACE32 about the eMMC Controller Address

The following command is used to inform TRACE32 about the base address of the eMMC controller.

FLASHFILE.CONFIG *<mmc_controller_base_address>* , , , represents don't-care parameters.

For information about the base address, refer to the manufacturer's data sheet.

Example

```
; Base address of the eMMC controller in the AT91SAM3U  
FLASHFILE.CONFIG 0x40000000 , ,
```

Informing TRACE32 about the eMMC Flash Programming Algorithm

The following command is available to inform TRACE32 about the eMMC Flash programming algorithm:

FLASHFILE.TARGET *<code_range>* *<data_range>* *<file>*

Specify the eMMC Flash programming driver and where it runs in the target RAM.

Parameters

- *<code_range>*
Define an address range in the target's RAM to which the eMMC Flash programming algorithm is loaded.

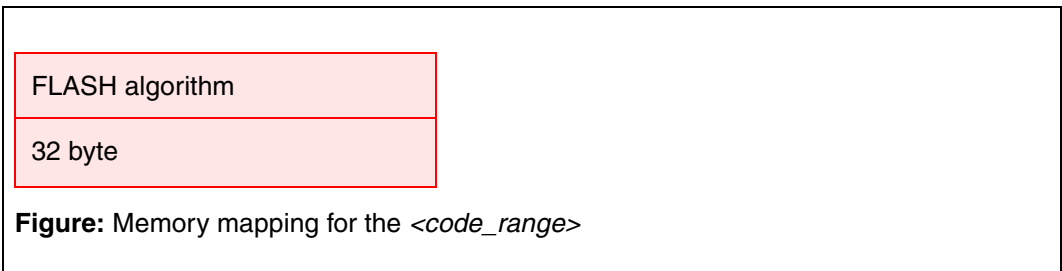

Required size for the code is: `size_of(<file>)` + 32 byte

- `<data_range>`

Define the address range in the target’s RAM where the programming data is buffered for the programming algorithm.

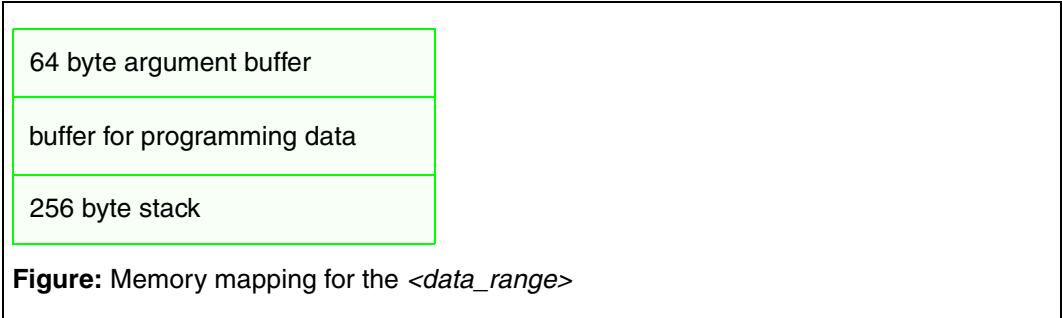

The argument buffer used for the communication between the TRACE32 software and the programming algorithm is located at the first 64 bytes of `<data_range>`. The 256 byte stack is located at the end of `<data_range>`.

`<buffer_size>` =
`size_of(<data_range>)` - 64 byte argument buffer - 256 byte stack

`<buffer_size>` is the maximum number of bytes that are transferred from the TRACE32 software to the eMMC Flash programming algorithm in one call.

- `<file>`

Lauterbach provides ready-to-run driver binary files for eMMC Flash programming. They are located in the TRACE32 installation directory:

```
~~/demo/<architecture>/flash/byte
```

Where `~~` is expanded to the TRACE32 installation directory, which is `c:/t32` by default.

For detailed information about how to determine the `<file>` parameter, see **“Identifying the Correct Driver Binary File for an eMMC Flash Device”**, page 18.

Identifying the Correct Driver Binary File for an eMMC Flash Device

1. For information about supported Flash devices, access the [Lauterbach](#) website.
2. Click the + tree button next to **Tool Chain**, and then click **Supported NAND/Serial Flash Controller** (www.lauterbach.com/supported-platforms/toolchain/flash-controllers).
3. Open **Supported Flash Devices** in a separate window or tab (www.lauterbach.com/supported-platforms/toolchain/flash-devices).
4. On the **Supported Flash Devices** page, select the required company from the drop-down list.

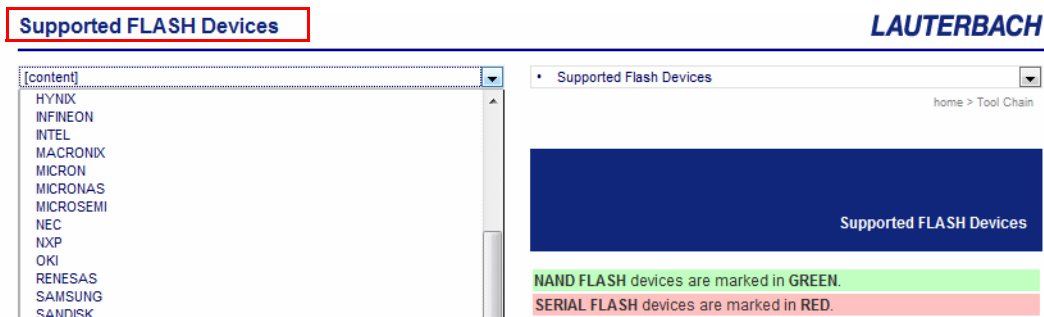

5. Locate the desired Flash device.

You need the name of the Flash device to be able to identify the correct driver binary file.

The file name convention for driver binary files is explained below. In addition, an example illustrates how to apply the file name convention in practice.

File Name Convention for eMMC Flash Drivers

eMMC Flash drivers for eMMC controllers use the following file name convention:

eMMC_CPU.bin

where **CPU** is the CPU family name.

Example for eMMC Controllers

Target:

- CPU **OMAP3530** with the eMMC controller **omap3530**
- eMMC Flash device **NAND16GXH**

Taken together, the **Code** column and the **Controller** column make up the file name of the eMMC Flash driver binary file: **emmc_omap.bin**.

The image shows two screenshots of supported device lists. The top screenshot is for Texas Instruments, and the bottom is for Micron Technology, Inc. Red boxes highlight 'Supported NAND/Serial Flash Controller' in the left sidebar and 'OMAP3530' in the controller column of the TI table. A blue arrow points from 'omap3530' in the TI table to 'eMMC' in the code column of the Micron table. Another red box highlights 'Supported Flash Devices' in the left sidebar of the Micron screenshot, with a red box around 'NAND16GXH' in the type column.

CPU	CONTROLLER	COMMENT
DM320	generic	NAND
⋮	⋮	⋮
OMAP34XX	generic	NAND
OMAP3530	omap3530	eMMC
OMAP35XX	generic	NAND

TYPE	COMPANY	CODE	COMMENT
28F00AM29EW	MICRON	M29EW	16-bit mode
		M29EWB	8-bit mode
NAND08GW3B	MICRON	NAND2G08L	NAND-Flash
NAND16GXH	MICRON	eMMC	eMMC
NAND32GXH	MICRON	eMMC	eMMC
NAND512R3A	MICRON	NAND1208	NAND-Flash

The binary file resides in this folder: `~/demo/arm/flash/byte`

Where `~` is expanded to the TRACE32 installation directory, which is `c:/t32` by default.

This results in the following command line:

```
; Specify the eMMC Flash programming algorithm and where it runs in  
; the target RAM.      <code_range>      <data_range>      <file>  
FLASHFILE.TARGET 0x4020000++0x1FFF 0x4022000++0x1FFF  
                        ~/demo/arm/flash/byte/emmc_omap.bin
```

FLASHFILE Declaration Examples

Declaration Example 1

CPU: OMAP4430 (Texas Instruments)

Base address of the eMMC controller: 0x480B4000

Driver file: `~/demo/arm/flash/byte/emmc_omap.bin`
Where `~` is expanded to the TRACE32 installation directory, which is `c:/t32` by default.

```
...  
  
; Reset the FLASHFILE declaration within TRACE32.  
FLASHFILE.RESet  
  
; Base address of the eMMC controller in the OMAP4430  
FLASHFILE.CONFIG 0x480B4000 , ,  
  
; Specify the eMMC Flash programming algorithm and where it runs on  
; the target RAM. <code_range> <data_range> <file>  
FLASHFILE.TARGET 0x40301000++0x1FFF 0x40303000++0x2FFF  
                                ~/demo/arm/flash/byte/emmc_omap.bin  
  
...
```

Declaration Example 2

CPU: AT91SAM3U4 (ATMEL)
Base address of the eMMC controller: 0x40000000
Driver file: `~/demo/arm/flash/byte/emmc_at91sam.bin`
Where `~` is expanded to the TRACE32 installation directory, which is `c:/t32` by default.

```
...  
  
; Reset the FLASHFILE declaration within TRACE32.  
FLASHFILE.RESet  
  
; Base address of the eMMC controller in the AT91SAM3U4  
FLASHFILE.CONFIG 0x40000000 , ,  
  
; Specify the eMMC Flash programming algorithm and where it runs on  
; the target RAM. <code_range> <data_range> <file>  
FLASHFILE.TARGET 0x20000000++0x1FFF 0x20002000++0x1FFF  
                                ~/demo/arm/flash/byte/emmc_at91sam.bin  
  
...
```

Checking the Identification from the eMMC Flash Device

The following command can be used to check if TRACE32 can access the eMMC Flash device:

FLASHFILE.GETID

Get the ID values of the eMMC Flash device.

```
; Open the TRACE32 AREA window.
```

AREA.view

```
; Check the access to the eMMC Flash device
```

```
; by getting the manufacturer ID and the device ID.
```

FLASHFILE.GETID

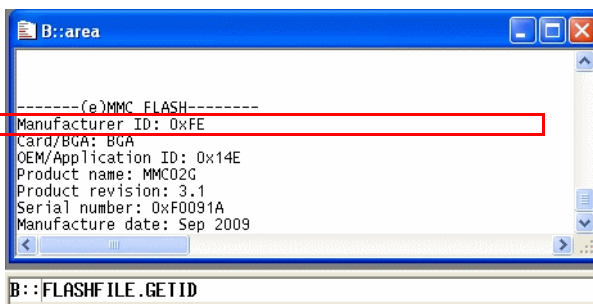

```
B::area
-----eMMC FLASH-----
Manufacturer ID: 0xFE
Card/BGA: BGA
OEM/Application ID: 0x14E
Product name: MMC02G
Product revision: 3.1
Serial number: 0xF0091A
Manufacture date: Sep 2009

B::FLASHFILE.GETID
```

Erasing the eMMC Flash Device

The following command is available to erase eMMC Flash devices:

FLASHFILE.Erase <range>

Erase a specified range of the eMMC Flash device.

Example:

```
; Erase 2MB starting at 0x0.  
FLASHFILE.Erase 0x0--0x1FFFFFF
```

Programming the eMMC Flash Device

The following commands are available to program the eMMC Flash:

FLASHFILE.LOAD <file> [<address> | <range>]

Program the eMMC Flash.

FLASHFILE.LOAD <file> [<address> | <range>] /ComPare

Verify the contents of the file against the eMMC Flash.

The data from <file> is written to the address range specified by <range>. If no <range> or <address> is specified, programming starts at address 0x0.

Example 1:

```
; Program the contents of my_file.bin to the eMMC Flash memory starting  
; at address 0x0.  
FLASHFILE.LOAD my_file.bin 0x0
```

Example 2:

```
; Verify the contents of my_file.bin against the eMMC Flash memory  
; starting at address 0x0.  
FLASHFILE.LOAD my_file.bin 0x0 /ComPare
```

Copying the eMMC Flash Memory

The following command is available to copy:

- Any data from any CPU memory area to the eMMC Flash memory, or
- Any data from one address range of the eMMC Flash to another address range within the same eMMC Flash memory; for example, for backup purposes.

FLASHFILE.COPY <source range> <target addr>

Copy data from the source range to the defined address of the eMMC Flash.

FLASHFILE.COPY <source range> <target addr> /ComPare

Verify the source range data against the target range data.

Example 1:

```
; Copy the 1MB virtual memory data at 0x0 to the eMMC Flash address  
; at 0x100000.  
; VM: The virtual memory of the TRACE32 software.  
FLASHFILE.COPY VM: 0x0--0xFFFFF 0x100000
```

Result (1):

Data is copied from the CPU to the eMMC Flash

Example 2:

```
; Verify the data between virtual memory and eMMC Flash.  
FLASHFILE.COPY VM: 0x0--0xFFFFF 0x100000 /ComPare
```

Example 3:

```
; Copy the 1MB eMMC Flash data at 0x0 to the eMMC Flash  
; at 0x800000.
```

```
FLASHFILE.COPY 0x0--0xFFFFF 0x800000
```

```
; Verify the 1MB eMMC Flash data between 0x0 and 0x800000.
```

```
FLASHFILE.COPY 0x0--0xFFFFF 0x800000 /ComPare
```

Modifying the eMMC Flash Memory

The following command is available to modify the contents of the eMMC Flash memory.

FLASHFILE.Set [*<address>* | *<range>*] %*<format>* *<data>* Modify the contents of the eMMC Flash.

Example 1:

```
; Write 4 bytes of data 0x12345678 to the address 0x100000.  
; LE = little endian  
FLASHFILE.Set 0x100000 %LE %Long 0x12345678
```

Example 2:

```
; Write data 0x0 from 0x100000 to 0x13FFFF in the eMMC Flash.  
FLASHFILE.Set 0x100000++0x13FFFF %Long 0x0
```

Result (1)

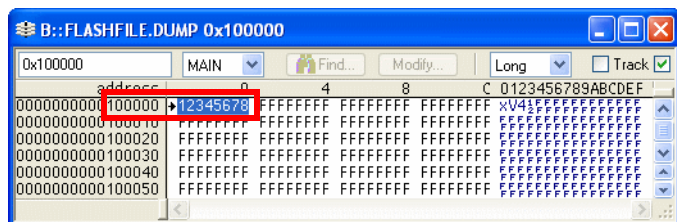

Other Useful Commands

The CPU cannot read eMMC Flash memories directly. But TRACE32 provides special commands for reading eMMC Flash memories. The contents of the eMMC Flash are displayed in a window.

Reading the eMMC Flash

The following command allows to read the eMMC Flash memory.

FLASHFILE.DUMP [*<address>*] [*/!<format>*]

Display a hex-dump of the eMMC Flash.

Example:

```
; Display a hex-dump of the eMMC Flash starting at 0x1000.  
; Display the information in 2-bit format (/Long option).  
FLASHFILE.DUMP 0x1000 /Long
```

Result

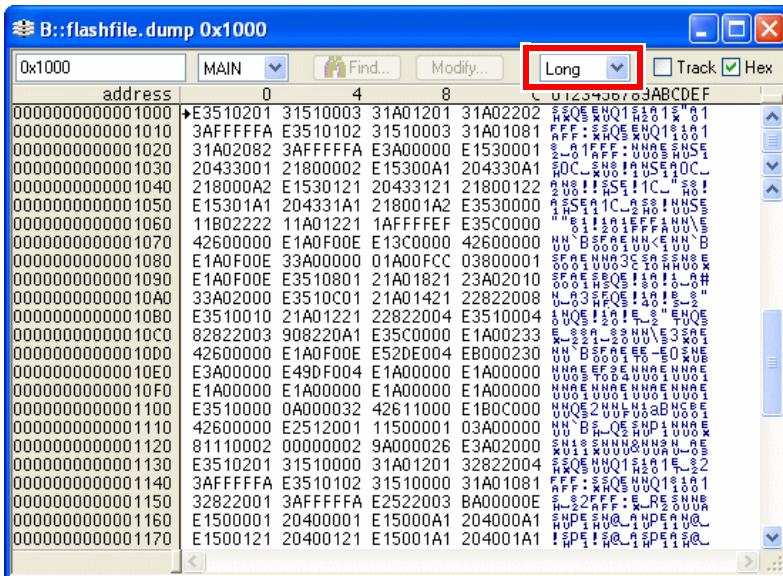

Saving the eMMC Flash Device

The following command is available to save the contents of the eMMC Flash memory to a file.

FLASHFILE.SAVE *<file>* *<range>*

Save the contents of the eMMC Flash memory into *<file>*.

Example:

```
; Save 1MB of the eMMC Flash data starting at 0x0 to the file  
; my_dump.bin.  
FLASHFILE.SAVE my_dump.bin 0x0--0xFFFFF
```

Example 1

CPU: OMAP4430
eMMC Flash: SanDisk, iNAND 8 GBytes
Internal SRAM: 0x40301000
SD/MMC Controller Register: 0x480B4000 (MMCHS2)

```
SYStem.RESet

system.CPU omap4430

SYStem.JtagClock 10.Mhz

SYStem.Option.DACR ON ; Give debugger global write permissions.
SETUP.IMASKASM OFF ; Lock interrupts while single stepping.
SYSTEM.MEMACCESS DAP ; Enable DAP access.

TrOnchip.set DABORT OFF

TrOnchip.set PABORT OFF

TrOnchip.Set UNDEF OFF

SYStem.mode.attach

wait 1.s

if run()

break

GOSUB disable_watchdog

D.S NSD:0x480B422C %LE %Long 0xe0f87 ; Configure the eMMC clock.
; LE = little endian

BREAK.RESet

FLASHFILE.RESet

; Base address of the eMMC controller in the OMAP4430
FLASHFILE.CONFIG 0x480B4000 , ,
```

```

; Specify the eMMC Flash programming algorithm and where it runs in
; the target RAM.  <code_range>          <data_range>          <file>
FLASHFILE.TARGET 0x40301000++0x1FFF 0x40303000++0x1FFF
~/demo/arm/flash/byte/emmc_omap.bin

; Check the access to the eMMC Flash device
; by getting the manufacturer ID and the device ID.
FLASHFILE.GETID

DIALOG.YESNO "Program flash memory?"

ENTRY &progflash

IF &progflash

(; Erase Flash.

FLASHFILE.ERASE 0x0--0xFFFFFFFF

; Write Flash.
FLASHFILE.LOAD * 0x0

; Verify Flash.
FLASHFILE.LOAD * 0x0 /ComPare

)

; Display a hex-dump of the eMMC Flash starting at 0x0.
FLASHFILE.DUMP 0x0

ENDDO

```

Example 2

CPU: DM365
eMMC Flash: Numonyx, NAND16GXH is connected to the MMC0 controller.
SDRAM: 0x80002000
eMMC Controller Register: 0x01D11000

```
SYStem.Down
SYStem.JtagClock 1Mhz

SYStem.RESet
SYStem.CPU DM365
SYStem.o.rb off
SYStem.JtagClock 1Mhz
SYStem.mode go
wait 1.s
if run()
break

; Enable for the eMMC.
Data.Set 0x1C48018 %Long 0x4000000 ; Enable for MMC0 controller

; Configure eMMC CLK.
Data.Set 0x01D11004 %Long 0x0117 ; MMC CLK
Data.Set 0x01D11000 %Long 0x0007 ; MMC_CTL
Data.Set 0x01D11000 %Long 0x0000 ; MMC_CTL

FLASHFILE.RESet
Break.RESet

; Base address of the eMMC controller in the DM365.
FLASHFILE.CONFIG 0x01D11000 , ,

; Specify the eMMC Flash programming algorithm and where it runs in
; the target RAM. <code_range> <data_range> <file>
FLASHFILE.TARGET 0x80002000++0x1FFF 0x80004000++0x1FFF
~/demo/arm/flash/byte/emmc_dm365.bin

; Check the access to the eMMC Flash device
; by getting the manufacturer ID and the device ID.
FLASHFILE.GETID

DIALOG.YESNO "Program flash memory?"
ENTRY &progflash
IF &progflash

(; Erase FLASH.

FLASHFILE.ERASE 0x0--0xFFFFFFFF
```

```

; Write Flash.
  FLASHFILE.LOAD * 0x0

; Verify Flash.
  FLASHFILE.LOAD * 0x0 /ComPare

)

; Display a hex-dump of the eMMC Flash starting at 0x0.
  FLASHFILE.DUMP 0x0

ENDDO

```

FLASH Programming via Boundary Scan

The **BSDL** commands of TRACE32 are used to program external FLASH memories via boundary scan. Important BSDL-specific steps are:

- Check that the bypass mode works.
- Check that the IDCODE matches.
- Define the FLASH pin connection.
- Enable eMMC FLASH programming via boundary scan and define the flash type.

eMMC FLASH programming then continues with the **FLASHFILE** commands described in this manual. The following PRACTICE script (*.cmm) illustrates the BSDL-specific steps by way of this example for the MMC protocol:

```

CPU:                AT91SAM3U4
eMMC FLASH:         Numonyx, NAND16GXH
Pin connection:     MMC_CLK: Port A3
                   MMC_CMD: Port A4
                   MMC_DAT0: Port A5

```

```

SYSTEM.JtagClock 15.Mhz           ; set JTAG clock
BSDL.RESet                        ; reset boundary scan configuration
BSDL.FILE ./sam3u4e_lqfp144.bsd   ; load the required BSDL file

BSDL.HARDRESET                    ; toggle TRST_N pin
BSDL.SOFTRESET                    ; do a sequential JTAG reset

IF BSDL.CHECK.BYPASS()            ; check, if BYPASS mode works
(
  IF BSDL.CHECK.IDCODE()          ; check, if the IDCODE matches
  (
    BSDL.FLASH.IFDefine RESet     ; reset the boundary scan flash
                                ; configuration

    BSDL.FLASH.IFDefine MMC 1. 1. ; define boundary scan flash
                                ; interface:
                                ; - protocol: MMC
                                ; - MMC flash memory connected to
                                ;   IC1 of the boundary scan chain
                                ; - data with is 1 bit

    BSDL.FLASH.IFMAP CLK PA3      ; map generic MMC pin CLK to port PA3
    BSDL.FLASH.IFMAP CMD PA4      ; map generic MMC pin CMD to port PA4
    BSDL.FLASH.IFMAP DAT0 PA5     ; map generic MMC pin DAT0 to port PA5
    BSDL.FLASH.INIT SAFE          ; Initialize boundary scan chain to
                                ; safe values according to
                                ; SAFE state from BSDL file

    FLASHFILE.BSDLaccess ON      ; Enable flash programming
                                ; via boundary scan
    FLASHFILE.BSDLFLASHTYPE EMMC ; define flash type

    FLASHFILE.GETID              ; get the MMC flash memory ID
    ; continue with flash programming, e.g.
    ; FLASHFILE.DUMP 0x0
    ; FLASHFILE.ERASE 0x0--0xFFFFF
    ; FLASHFILE.LOAD * 0x0
  )
)
ENDDO

```